

HSF

NOTES:

Current Rating:12A max
 Voltage Rating:600V
 Contact Resistance:10mΩ max
 Withstand Voltage:2200V AC
 Operation Temperature:-55℃ to +105℃
 Contact Material:Copper Alloy
 Contact plating:
 SX:xxu" Gold on contact area,
 (See Ordering Information)
 50u" Nickel underplating overall.
 Housing Material:PBT+G.F.(UL94V-0),BK
 Cover Material:PBT+G.F.(UL94V-0),BK
 Stator Material:PBT+G.F.(UL94V-0),BK
 Open Tool Material:PA66,White
 Spring Material:Stainless.
 Wire Size Range:AWG18~14;

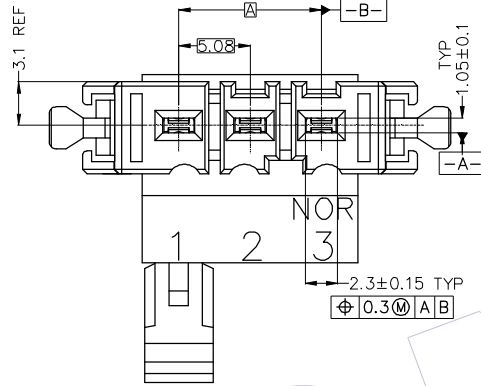
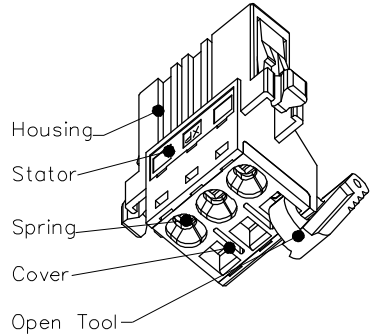

Pin	A	B	C	E
3	10.16	19.24	21.91	28.61
4	15.24	24.32	26.99	33.69
5	20.32	29.40	32.07	38.77
6	25.40	34.48	37.15	43.85

Ordering Information

WD5085 -1 HA XX XX B A XX X
 Row: _____
 1=Single
 Spring compression
 -Normal type
 No of Pins:
 03=3Pin; 04=4Pin;
 05=5Pin; 06=6Pin
 Contact Plated:
 S4=15u" Gold /Ni
 S5=30u" Gold /Ni
 Housing Color:
 B=Black
 Foolproof Type:
 01=X
 02=Y
 W="Wcon" logo
 M=Customer logo
 Blank=Without logo
 Packing
 A=Tray

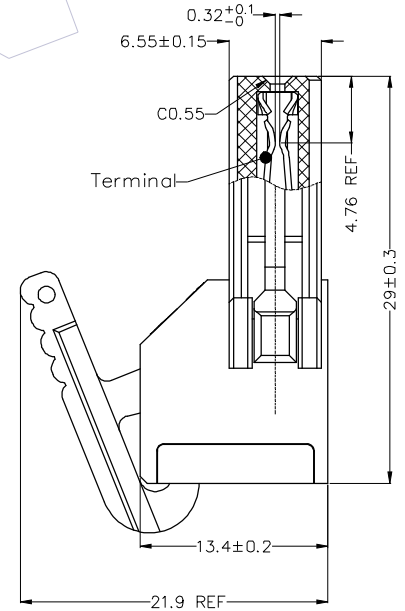
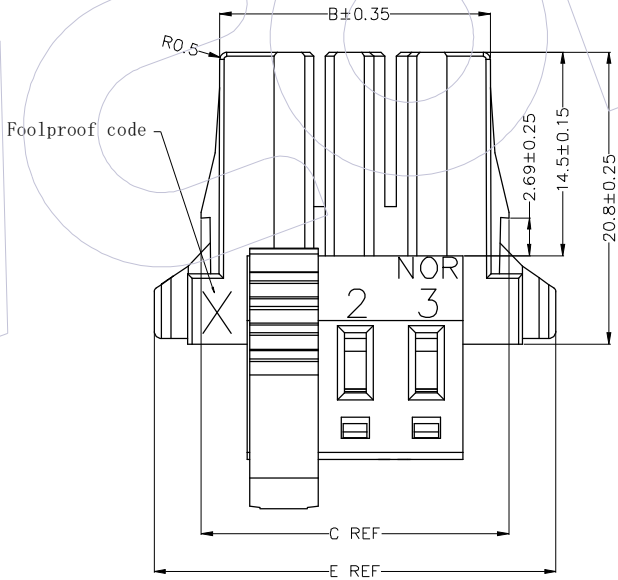

REV	DATE	MODIFICATION DESCRIPTION	CHANGE	OPERATION	DRAW	DATE	SCALE	Fit	PART NO.
A1	2024.07.18	Increase stripping size	—	x.x ±0.40	OHJ	2021.06.23	UNIT	mm	WD5085 -1HAXXXBAXXX
AO	2021.06.23	NEW	—	x.xx ±0.25	CHECK	DATE	SIZE	A4	TITLE: 5.08mm Dyn. (J Type) Single Row Spring compression TYPE (Normal type)
				x.xxx ±0.15	APPROVE	DATE	SHEET	1/2	Customer NO. —
				Angle ± 3°			PROJ.		
				DIM	TOL				

WCON

Http: www.wcon.com

WCON-Dongguan Tel: +86 769 85358920 Fax: +86 769 85358915 E-mail: sales@wcon.com
 WCON-Kunshan Tel: +86 512 57468408 Fax: +86 512 57468468 E-mail: salesks@wcon.com

HSF

WD5085-1HAXXXBA01 W

WD5085-1HAXXXBA01

Installation Instructions:

"Wcon" logo

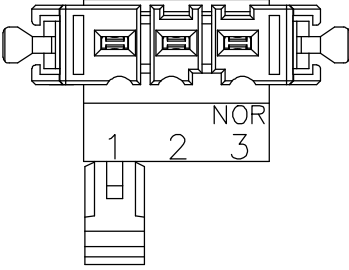

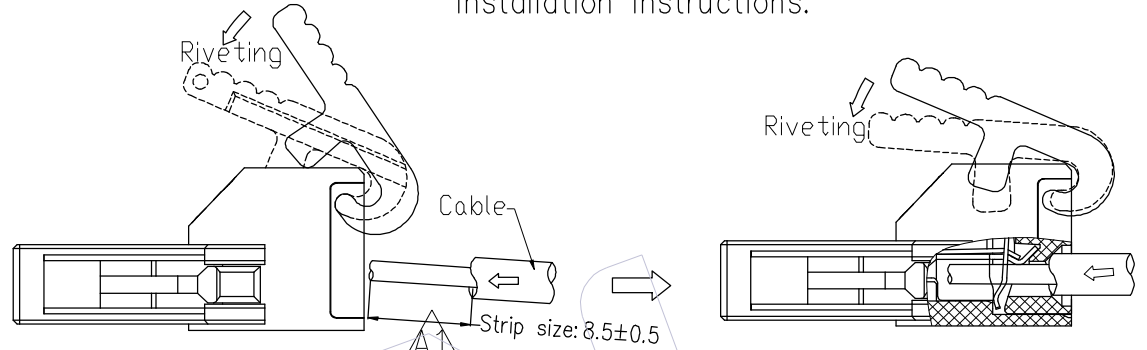
PIN		3P	4P	5P	6P
Foolproof					
	X	WD5085-1HA03XXBA01 	WD5085-1HA04XXBA01 	WD5085-1HA05XXBA01 	WD5085-1HA06XXBA01 
	Y	WD5085-1HA03XXBA02 	WD5085-1HA04XXBA02 	WD5085-1HA05XXBA02 	WD5085-1HA06XXBA02 

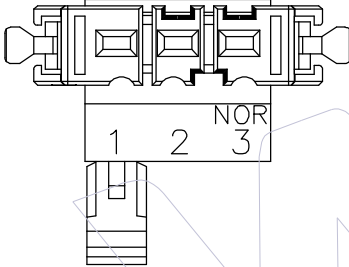
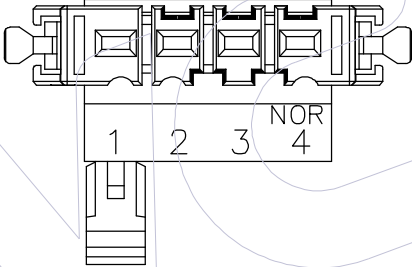
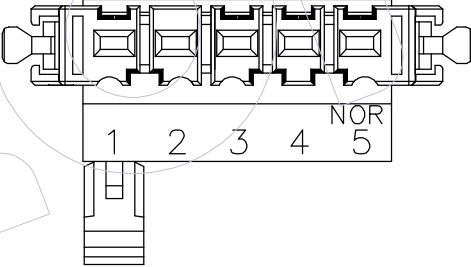
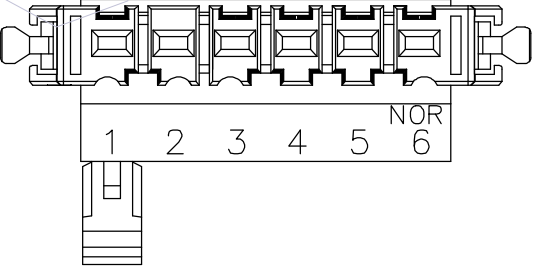
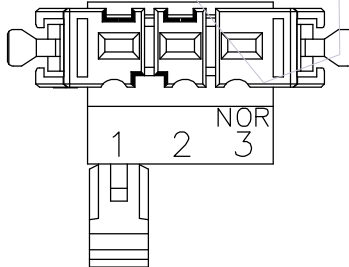
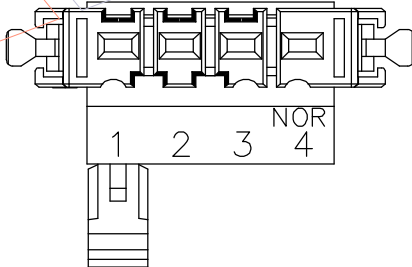
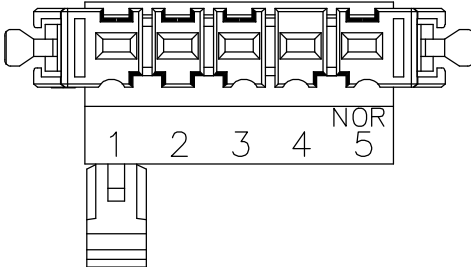
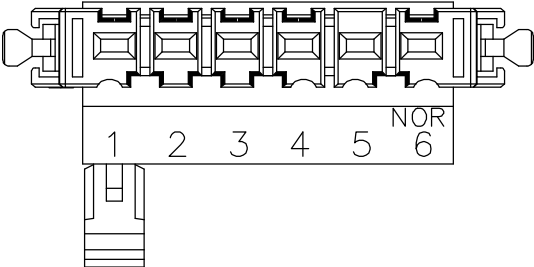
REV	DATE	MODIFICATION DESCRIPTION	CHANGE	OPERATION	DRAW	DATE	SCALE	Fit	PART NO.
A1	2024.07.18	Increase stripping size	—	x.X ±0.40	OHJ	2021.06.23	UNIT	mm	WD5085 -1HAXXXBAXXX
AO	2021.06.23	NEW	—	x.XX ±0.25	CHECK	DATE	SIZE	A4	TITLE:
				x.XXX ±0.15	APPROVE	DATE	SHEET	2/2	5.08mm Dyn. (J Type) Single Row
				Angle ± 3°			PROJ.	⊕	Spring compression TYPE (Normal type)
				DIM TOL					Customer NO.

WCON
 Http: www.wcon.com

WCON-Dongguan Tel: +86 769 85358920 Fax: +86 769 85358915 E-mail: sales@wcon.com	WCON-Kunshan Tel: +86 512 57468408 Fax: +86 512 57468468 E-mail: salesks@wcon.com
---	--